

RATAS 100T6P2R1W

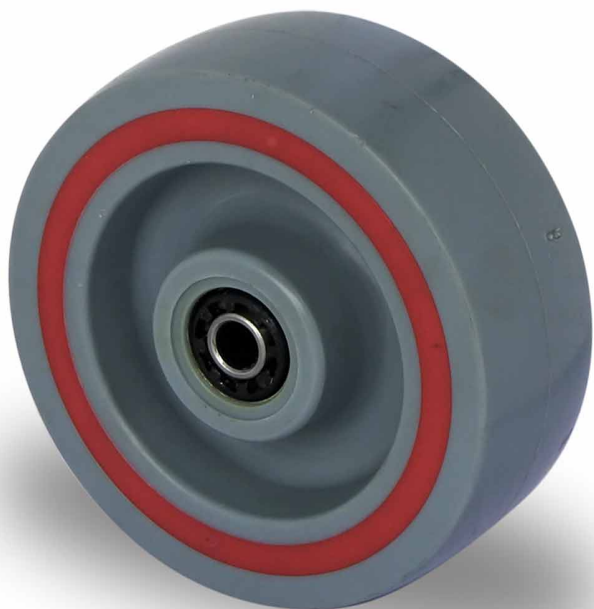

Toote SKU	100T6P2R1W
Standardivastavus	DIN EN 12532
Seeria	T6P2
Ratta materjal	ratta keskosa polüpropüleen (PP)
Protektor	turvis polüpropüleen (PP)
Temperatuurivahemik	-20°C kuni +60°C
Ratta läbimõõt	100mm
Kandevõime	160kg
Protektori laius	36mm
Ratta naba laius	40mm
Rattapoldi suurus	M8
Puksi läbimõõt	12mm
Kaal	0.29kg
Rattalaager	nõellaager



RATAS 100T6P2R1W

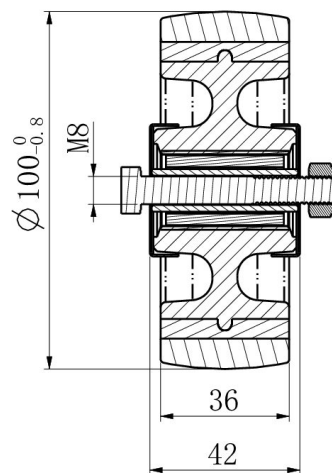

TD_100T6P2R1W		
load capacity	160KG	