

## RATAS 100M6N2B32



<b>Toote SKU</b>	100M6N2B32
<b>Standardivastavus</b>	DIN EN 12532
<b>Seeria</b>	M6N2
<b>Ratta materjal</b>	ratta keskosa polüamiid (PA)
<b>Protektor</b>	turvis polüamiid (PA)
<b>Temperatuurivahemik</b>	-20°C kuni +80°C
<b>Ratta läbimõõt</b>	100mm
<b>Kandevõime</b>	160kg
<b>Protektori laius</b>	36mm
<b>Ratta naba laius</b>	40mm
<b>Rattapoldi suurus</b>	M8
<b>Puksi läbimõõt</b>	8mm
<b>Rattalaager</b>	kuullaager





# RATAS 100M6N2B32

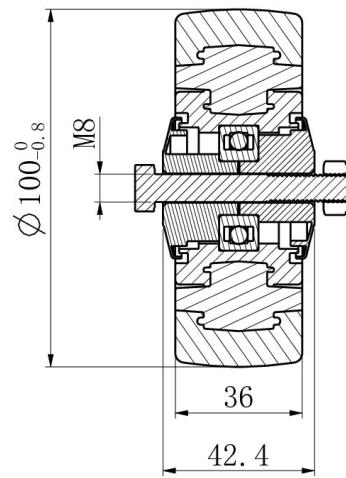
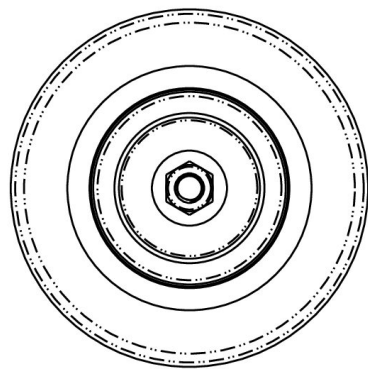

TD_100M6N2B32		
load capacity	160KG	