

RATAS 080R4F1R0N



Toote SKU	080R4F1R0N
Standardivastavus	DIN EN 12532
Seeria	R4F1
Ratta materjal	ratta keskosa polüamiid (PA)
Protektor	turvis elastne kumm (elastic)
Temperatuurivahemik	-20°C kuni +80°C
Ratta läbimõõt	80mm
Kandevõime	130kg
Protektori laius	35mm
Ratta naba laius	40mm
Rattapoldi suurus	M8
Puksi läbimõõt	12mm
Kaal	0.2kg
Rattalaager	nõellaager
Kummi kõvadus	75° Shore A





RATAS 080R4F1R0N

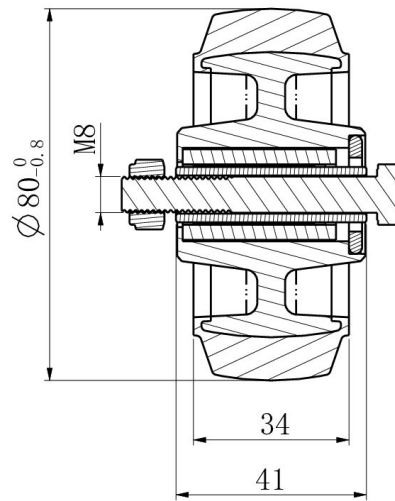

TD_080R4F1R0N		
load capacity	130KG	