

RATAS 080R4E1B34



Toote SKU	080R4E1B34
Standardivastavus	DIN EN 12532
Seeria	R4E1
Ratta materjal	ratta keskosa polüamiid (PA)
Protektor	turvis elastne kumm (elastic)
Temperatuurivahemik	-20°C kuni +80°C
Ratta läbimõõt	80mm
Kandevõime	150kg
Protektori laius	35mm
Ratta naba laius	40mm
Rattapoldi suurus	M8
Puksi läbimõõt	8mm
Kaal	0.16kg
Rattalaager	kuullaager
Kummi kõvadus	65° Shore A





RATAS 080R4E1B34

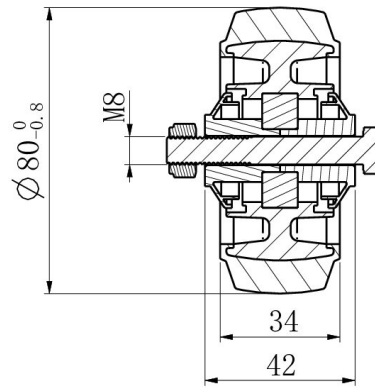

TD_080R4E1B34		
load capacity	150KG	