

RATTAKOMPLEKT HBH36WC100P2G2B32



Toote SKU	HBH36WC100P2G2B32
Standardivastavus	DIN EN 12532
Seeria	P2G2
Kinnitamine	Poltkinnitusega
Pidur ja suund	pöörlev ilma pidurita
Ratta materjal	ratta keskosa polüpropüleen (PP)
Protektor	turvis termoplastiline kumm
Temperatuurivahemik	-20°C kuni +60°C
Ratta läbimõõt	100mm
Kandevõime	100kg
Kogukõrgus	124mm
Protektori laius	32mm
Ratta naba laius	40mm
Nihe	40mm
Kinnituspoldi ava läbimõõt	13mm
Rattapoldi suurus	M8
Puksi läbimõõt	8mm
Kaal	0.51kg
Rattalaager	kuullaager
Kummi kõvadus	70° Shore A



RATTAKOMPLEKT HBH36WC100P2G2B32

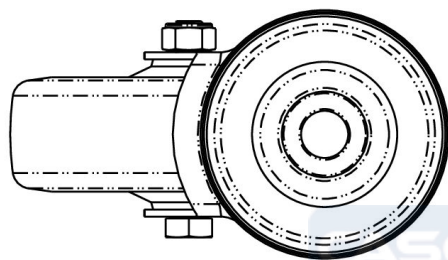
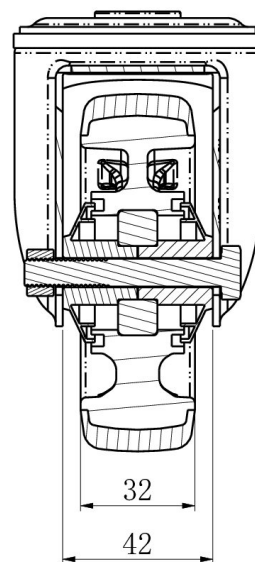
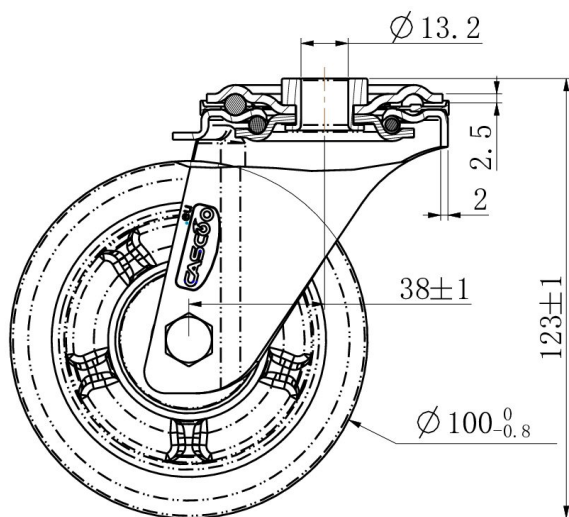

TD_HBH36WC100P2G2B32

load capacity

100KG

