

RATTAKOMPLEKT FPP55WC160P4S4R0N



Toote SKU	FPP55WC160P4S4R0N
Standardivastavus	DIN EN 12532
Seeria	P4S4
Kinnitamine	Plaatkinnitusega
Pidur ja suund	fikseeritud jooksuga
Ratta materjal	ratta keskosa polüpropüleen (PP)
Protektor	turvis täiskumm
Temperatuurivahemik	-20°C kuni +60°C
Ratta läbimõõt	160mm
Kandevõime	135kg
Kogukõrgus	195mm
Protektori laius	40mm
Ratta naba laius	59mm
Plaadi mõõtmed	135x110mm
Plaadi aukaugus	105x84/76mm
Rattapoldi suurus	M12
Puksi läbimõõt	20mm
Kaal	1.58kg
Rattalaager	nõellaager
Kummi kõvadus	85° Shore A



RATTAKOMPLEKT FPP55WC160P4S4R0N

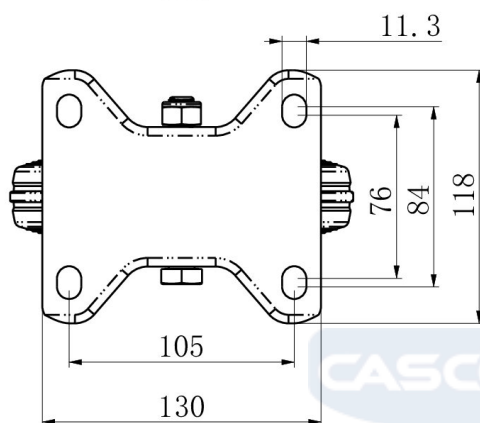
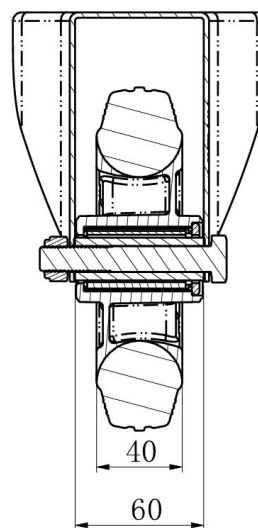
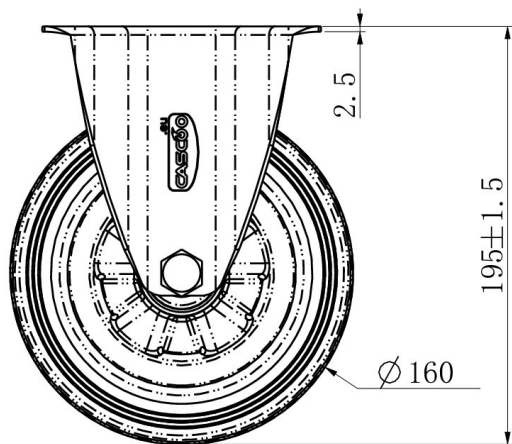

TD_FPP55WC160P4S4R0N		
load capacity	135KG	