

RATTAKOMPLEKT FPP55WC160P2G2B32A



Toote SKU	FPP55WC160P2G2B32A
Standardivastavus	DIN EN 12532
Seeria	P2G2 (antistaatiline)
Kinnitamine	Plaatkinnitusega
Pidur ja suund	fikseeritud jooksuga
Ratta materjal	ratta keskosa polüpropüleen (PP)
Protektor	turvis termoplastiline kumm
Temperatuurivahemik	-20°C kuni +60°C
Ratta läbimõõt	160mm
Kandevõime	135kg
Kogukõrgus	195mm
Protektori laius	40mm
Ratta naba laius	59mm
Plaadi mõõtmed	135x110mm
Plaadi aukaugus	105x84/76mm
Rattapoldi suurus	M12
Puksi läbimõõt	12mm
Kaal	1.23kg
Rattalaager	kuullaager
Special Features	antistaatiline



RATTAKOMPLEKT FPP55WC160P2G2B32A

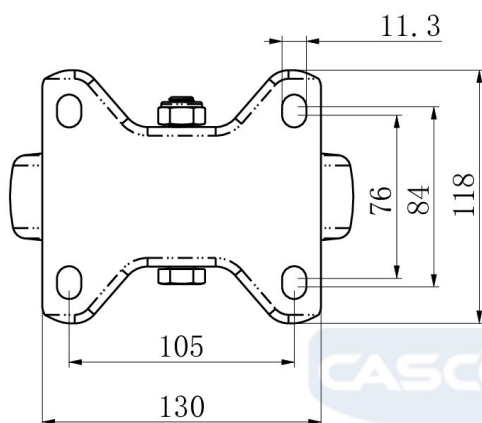
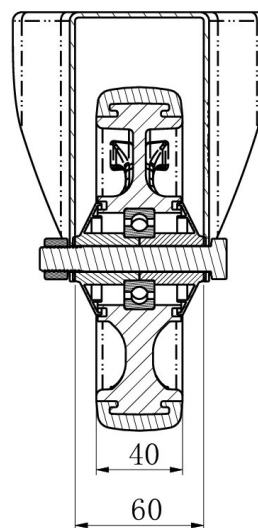
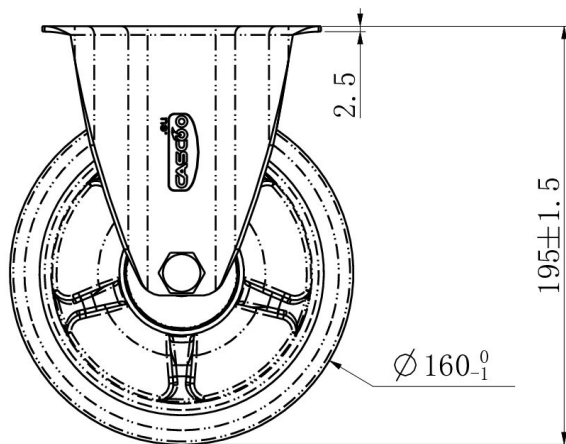

TD_FPP55WC160P2G2B32A		
load capacity	135KG	