

RATTAKOMPLEKT FBP32WC125P2D2B32A



Toote SKU	FBP32WC125P2D2B32A
Standardivastavus	DIN EN 12532
Seeria	P2D2 (antistaatiline)
Kinnitamine	Plaatkinnitusega
Pidur ja suund	fikseeritud jooksuga
Ratta materjal	ratta keskosa polüpropüleen (PP)
Protektor	turvis termoplastiline kumm
Temperatuurivahemik	-20°C kuni +60°C
Ratta läbimõõt	125mm
Kandevõime	120kg
Kogukõrgus	155mm
Protektori laius	40mm
Ratta naba laius	50mm
Plaadi mõõtmed	105x80mm
Plaadi aukaugus	80/77x60mm
Rattapoldi suurus	M10
Puksi läbimõõt	10mm
Kaal	0.67kg
Rattalaager	kuullaager
Special Features	antistaatiline



RATTAKOMPLEKT FBP32WC125P2D2B32A

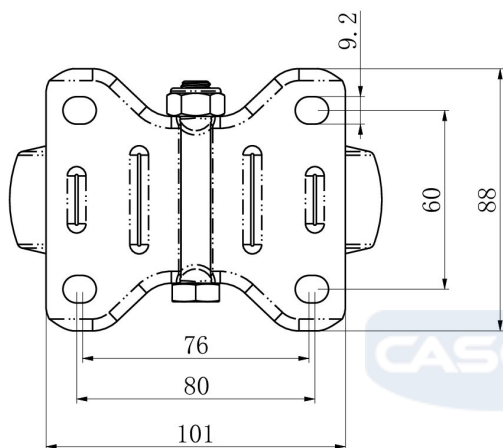
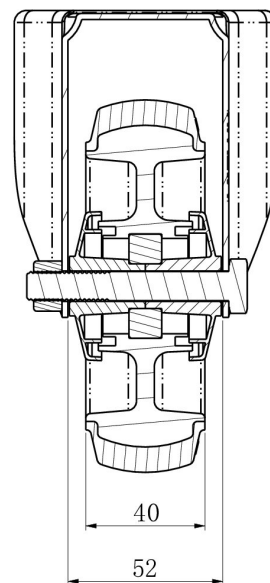
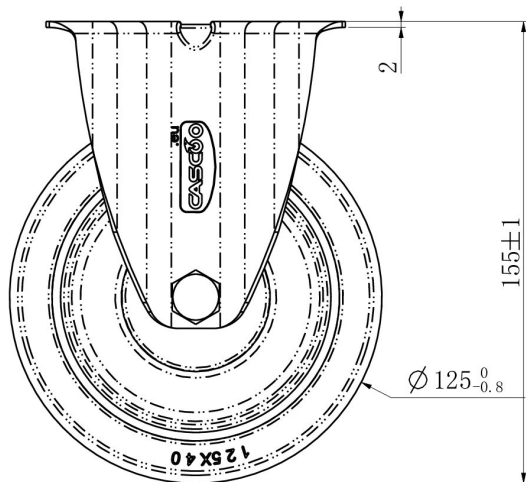

TD_FBP32WC125P2D2B32A		
load capacity	120KG	