

RATTAKOMPLEKT BPH85WC125R4E2B34



Toote SKU	BPH85WC125R4E2B34
Standardivastavus	DIN EN 12532
Seeria	R4E2
Kinnitamine	Poltkinnitusega
Pidur ja suund	tagapiduriga
Ratta materjal	ratta keskosa polüamiid (PA)
Protektor	turvis elastne kumm (elastic)
Temperatuurivahemik	-20°C kuni +80°C
Ratta läbimõõt	125mm
Kandevõime	160kg
Kogukõrgus	154mm
Protektori laius	38mm
Ratta naba laius	50mm
Nihe	45mm
Kinnituspoldi ava läbimõõt	13mm
Pöörderaadius	127mm
Rattapoldi suurus	M10
Puksi läbimõõt	10mm
Kaal	0.96kg
Rattalaager	kuullaager
Kummi kõvadus	65° Shore A



RATTAKOMPLEKT BPH85WC125R4E2B34

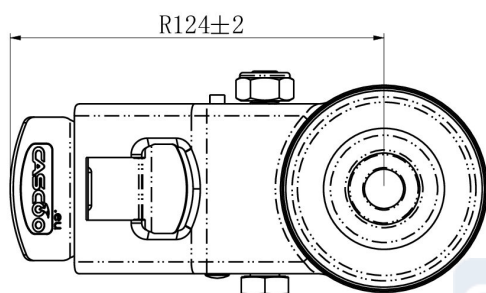
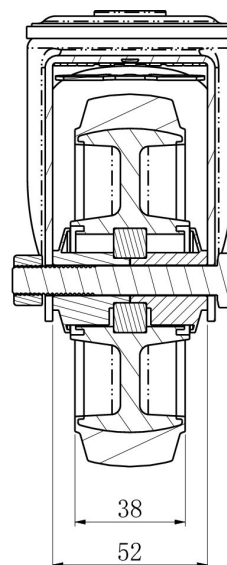
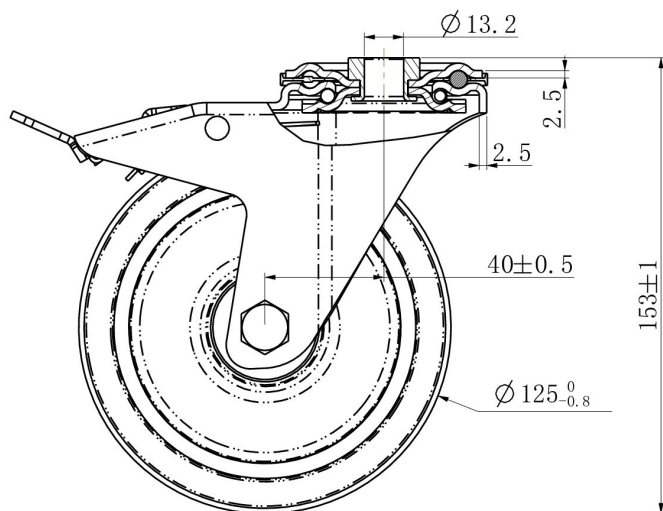

TD_BPH85WC125R4E2B34		
load capacity	150KG	