

RATTAKOMPLEKT BPH35WC080R4E1B34



Toote SKU	BPH35WC080R4E1B34
Standardivastavus	DIN EN 12532
Seeria	R4E1
Kinnitamine	Poltkinnitusega
Pidur ja suund	tagapiduriga
Ratta materjal	ratta keskosa polüamiid (PA)
Protektor	turvis elastne kumm (elastic)
Temperatuurivahemik	-20°C kuni +80°C
Ratta läbimõõt	80mm
Kandevõime	130kg
Kogukõrgus	104mm
Protektori laius	35mm
Ratta naba laius	40mm
Nihe	40mm
Kinnituspoldi ava läbimõõt	13mm
Pöörderaadius	127mm
Rattapoldi suurus	M8
Puksi läbimõõt	8mm
Kaal	0.96kg
Rattalaager	kuullaager
Kummi kõvadus	65° Shore A



RATTAKOMPLEKT BPH35WC080R4E1B34

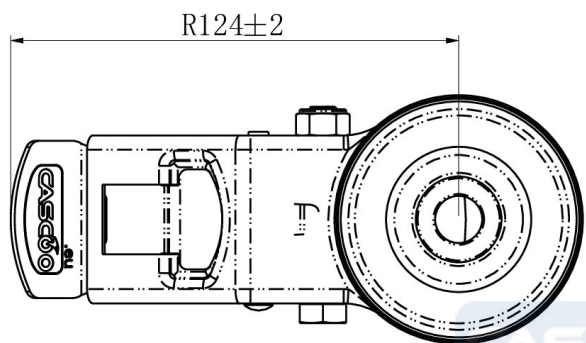
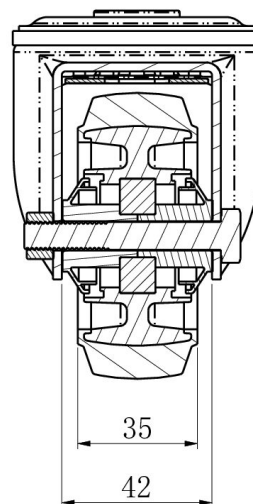
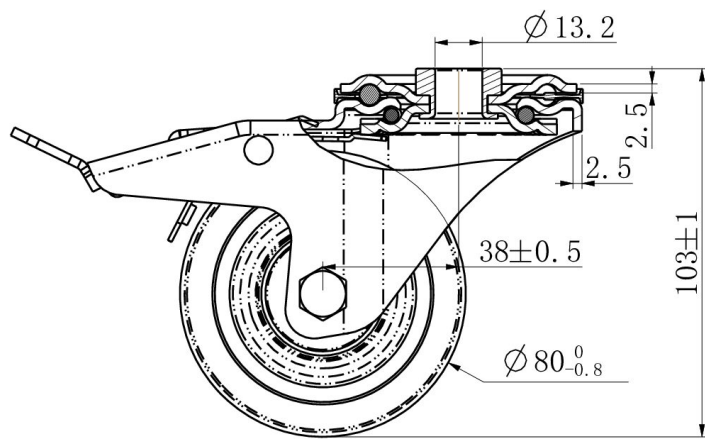

TD_BPH35WC080R4E1B34

load
capacity

130KG

