

RATTAKOMPLEKT BBH35WC100P2G2B32



Toote SKU	BBH35WC100P2G2B32
Standardivastavus	DIN EN 12532
Seeria	P2G2
Kinnitamine	Poltkinnitusega
Pidur ja suund	tagapiduriga
Ratta materjal	ratta keskosa polüpropüleen (PP)
Protektor	turvis termoplastiline kumm
Temperatuurivahemik	-20°C kuni +60°C
Ratta läbimõõt	100mm
Kandevõime	100kg
Kogukõrgus	124mm
Protektori laius	32mm
Ratta naba laius	40mm
Nihe	40mm
Kinnituspoldi ava läbimõõt	13mm
Pöörderaadius	127mm
Rattapoldi suurus	M8
Puksi läbimõõt	8mm
Kaal	0.73kg
Rattalaager	kuullaager
Kummi kõvadus	70° Shore A



RATTAKOMPLEKT BBH35WC100P2G2B32

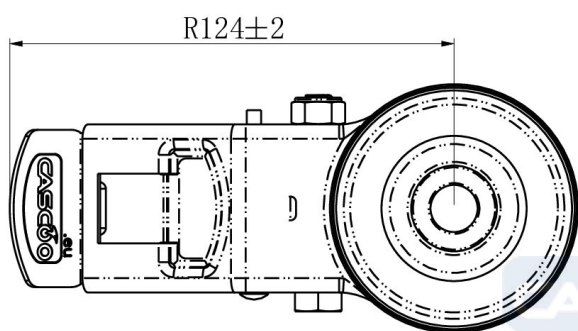
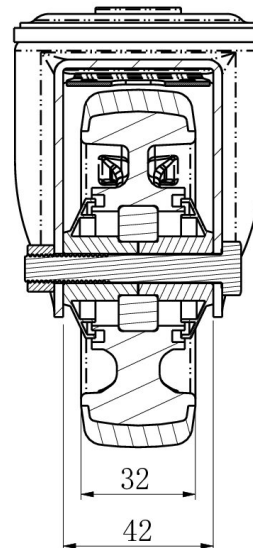
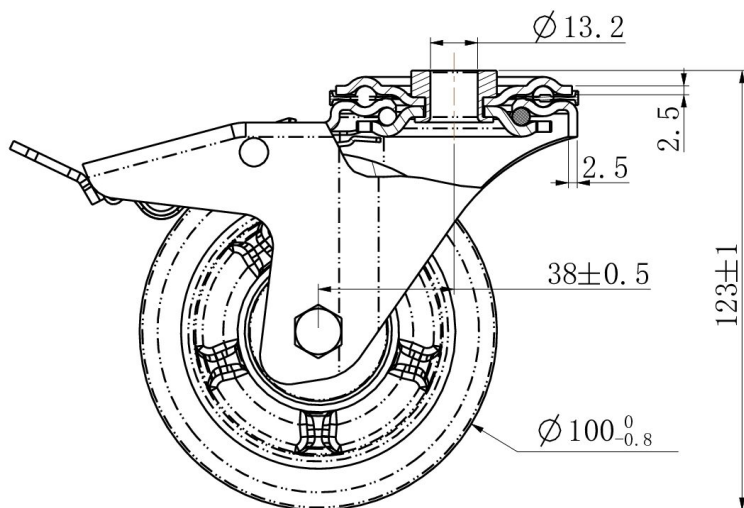

TD_BBH35WC100P2G2B32		
load capacity	100KG	