

RATTAKOMPLEKT BBH35WC100P2D2B32E

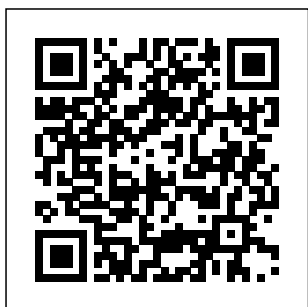

Toote SKU	BBH35WC100P2D2B32E
Standardivastavus	DIN EN 12532
Seeria	P2D2 (ESD)
Kinnitamine	Poltkinnitusega
Pidur ja suund	tagapiduriga
Ratta materjal	ratta keskosa polüpropüleen (PP)
Protektor	turvis termoplastiline kumm
Temperatuurivahemik	-20°C kuni +60°C
Ratta läbimõõt	100mm
Kandevõime	90kg
Kogukõrgus	124mm
Protektori laius	35mm
Ratta naba laius	40mm
Nihe	40mm
Kinnituspoldi ava läbimõõt	13mm
Pöörderaadius	127mm
Rattapoldi suurus	M8
Puksi läbimõõt	8mm
Kaal	0.88kg
Rattalaager	kuullaager
Special Features	elektrostaatiline (ESD)



RATTAKOMPLEKT BBH35WC100P2D2B32E

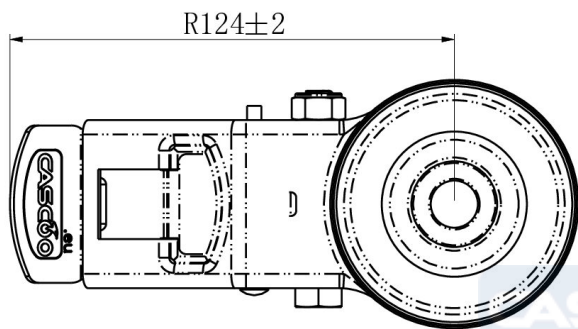
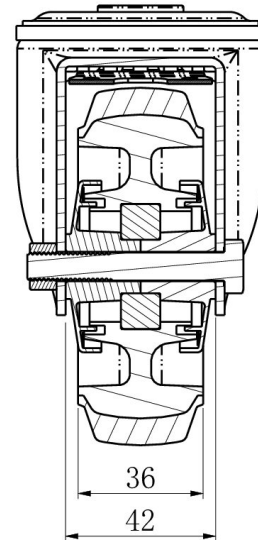
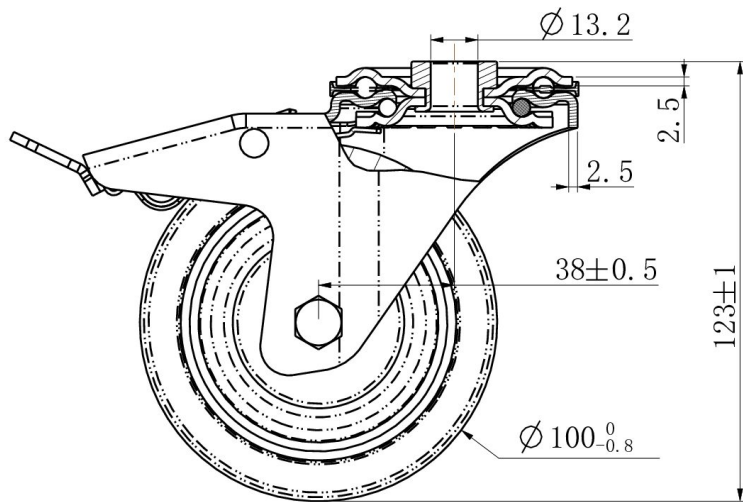

TD_BBH35WC100P2D2B32E		
load capacity	90KG	